

hama

00188234



MOBILE BLUETOOTH® SPEAKER

"Bomb 3.0"



Read the warnings and safety instructions on the enclosed note before using the product.

Lesen Sie vor der Nutzung des Produktes die Warn- und Sicherheitshinweise auf dem beiliegenden Hinweiszettel.

F Veuillez lire les avertissements et consignes de sécurité de la fiche ci-jointe avant d'utiliser le produit. **E** Antes de utilizar el producto, lea las advertencias e instrucciones de seguridad en la hoja de información adjunta. **NL** Lees voordat u van het product gebruikmaakt, de waarschuwingen en veiligheidsinstructies op het bijgevoegde informatieblad. **I** Prima dell'uso leggere attentamente le indicazioni di avvertimento e di sicurezza riguardanti il prodotto riportate sul foglio illustrativo.

PL Przed użyciem produktu należy zapoznać się z treścią wskazówek ostrzeżeń i wskazówek bezpieczeństwa znajdujących się na dołączonej ulotce informacyjnej. **H** A termék használata előtt olvassa el a mellékelt tájékoztatólapon található biztonsági előírásokat és figyelmeztetéseket. **RO** Înaintea utilizării produsului citiți avertizările și instrucțiunile de siguranță de pe fișa cu informații anexată.

CZ Před použitím si přečtěte výstražné a bezpečnostní pokyny uvedené na letáku přiloženém k produktu. **SK** Pred použitím výrobku si prečítajte výstražné a bezpečnostné upozornenia na priloženom listku s upozornením. **P** Antes da utilização do produto, leia os avisos e as indicações de segurança no folheto de instruções fornecido. **S** Läs varnings- och säkerhetsanvisningarna på medföljande informationsblad innan produkten används. **RUS** Перед использованием изделия ознакомьтесь с приложенными в комплекте правилами техники безопасности.

BG Преди да използвате продукта, прочетете предупредителните указания и инструкциите за безопасност в приложението информационен лист. **GR** Πριν από τη χρήση του προϊόντος διαβάστε τις υποδείξεις ασφαλείας και προειδοποίησης στο παρεχόμενο σημείωμα οδηγιών. **TR** Ürünü kullanmadan önce ekteki bilgi notunda bulunan uyarı ve güvenlik bilgilerini okuyun. **FIN** Lue ennen tuotteen käyttöä ohjelehtisessä olevat varoitukset ja turvaohjeet.

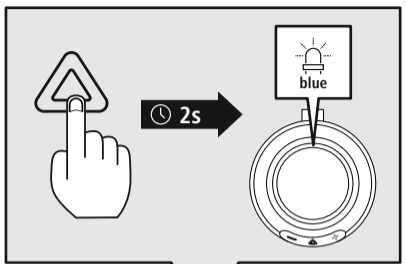
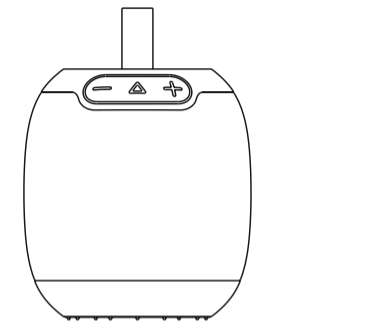

STAND BY

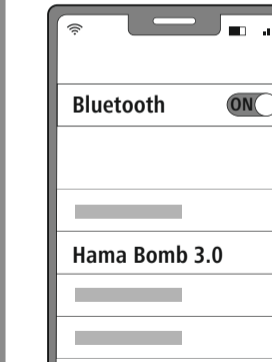
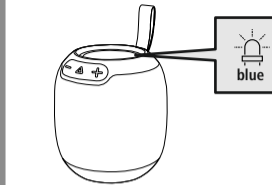
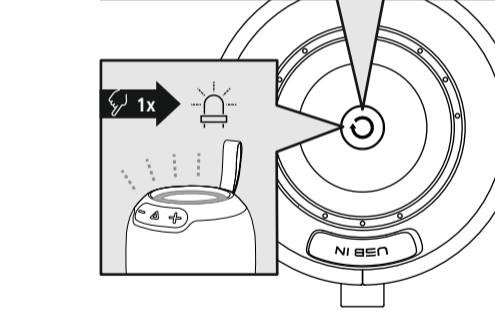
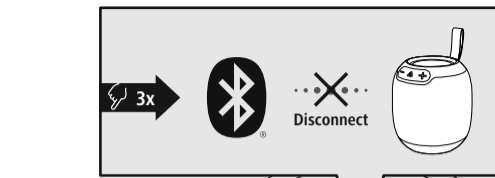
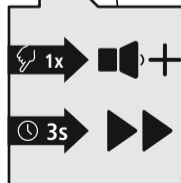
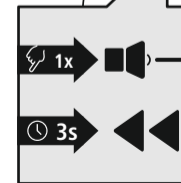
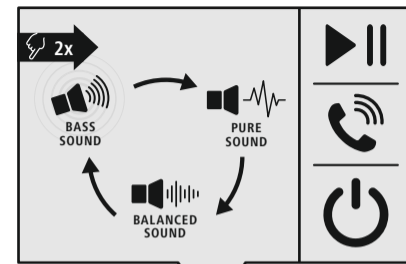

Password
0000



1 DO NOT CONNECT!
SMARTPHONE AND SPEAKER

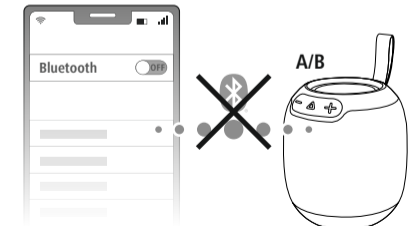
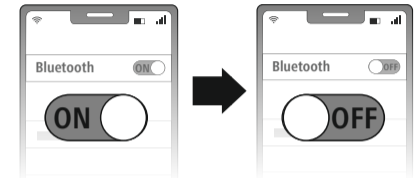

2

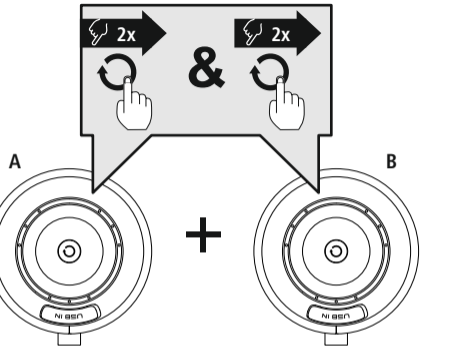

A + B CONNECT!

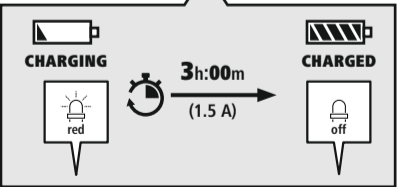
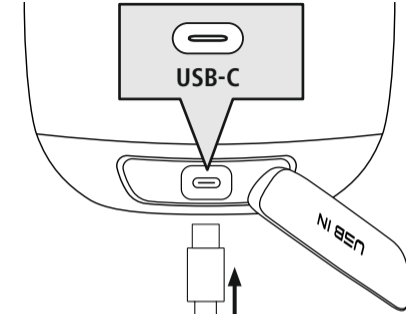
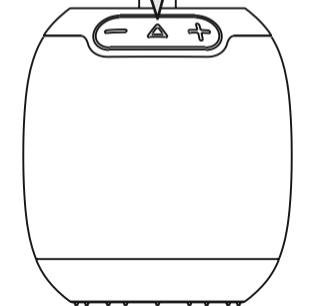
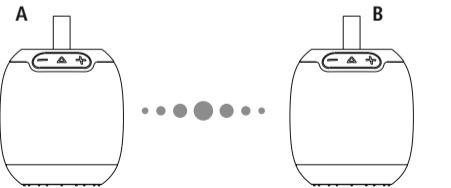

www.hama.com
00188234
Downloads



<https://www.hama.com/00188234>

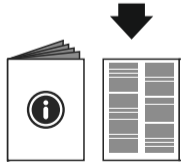

hama
Hama GmbH & Co KG
86652 Monheim / Germany

Service & Support
www.hama.com
+49 9091 502-0
D GB

"The Bluetooth® word mark and logos are registered trademarks owned by the Bluetooth SIG, Inc. and any use of such marks by Hama GmbH & Co KG is under license. Other trademarks and trade names are those of their respective owners."

All listed brands are trademarks of the corresponding companies. Errors and omissions excepted, and subject to technical changes. Our general terms of delivery and payment are applied.

00188234/02.24